

Operation Manual

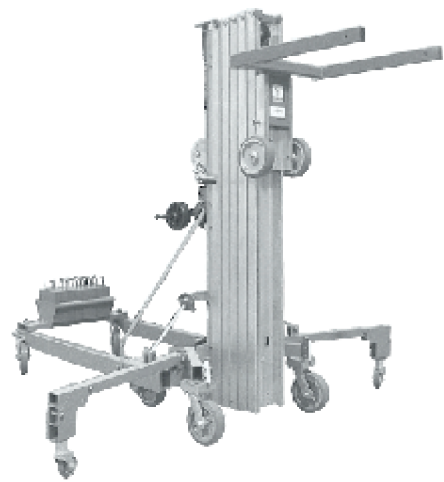

Wienold Superlift with Counterweights

SLK

SLK 10
SLK 15
SLK 20
SLK 25

Wienold-LIFTE.de

Release: 2.0
25.05.2021

Important

Read, understand and obey these safety rules and operating instructions before operating this machine. Only trained and authorized personnel shall be permitted to operate this machine. This manual should be considered a permanent part of your machine and should remain with the machine at all times. If you have any questions, call Genie Industries.

Contents

| | Page |
|--|-------------|
| Safety | 3 |
| Legend | 8 |
| Pre-operation Inspection | 9 |
| Function Tests | 11 |
| Workplace Inspection | 15 |
| Operating Instructions..... | 16 |
| Load Capacity Charts | 18 |
| Transport and Lifting Instructions | 20 |
| Specifications | 21 |

Contact us:

Phone: +49 5903 - 93 94 0
Internet: www.wienold-lifte.de
e-mail: info@wienold-lifte.de

Safety Rules



Warning

Failure to obey the instructions and safety rules in this manual may result in death or serious injury.

Do Not Operate Unless:

- You learn and practice the principles of safe machine operation contained in this operator's manual.

1 Avoid hazardous situations.

Know and understand the safety rules before going on to the next section.

- 2 Always perform a pre-operation inspection.
 - 3 Always perform the function tests prior to use.
 - 4 Inspect the workplace.
 - 5 Only use the machine as it was intended.
- You read, understand and obey the manufacturer's instructions and safety rules—safety and operator's manuals and machine decals.
 - You read, understand and obey employer's safety rules and worksite regulations.
 - You read, understand and obey all applicable governmental regulations.
 - You are properly trained to safely operate the machine.

SAFETY RULES

Fall Hazards

Do not use the machine as a personnel lifting platform or step.

Do not stand on the load handling attachments.

Do not climb on the mast.

Tip-over Hazards

Do not raise the load unless the stabilizers (if equipped) and legs have been fully lowered and locked and the casters are in full contact with the ground.

Do not raise the load unless the leg retainer pins are properly inserted through the leg and the base.

Do not remove the leg retainer pins while the machine is loaded and/or raised.

Do not raise the load unless the machine is on a firm, level surface.

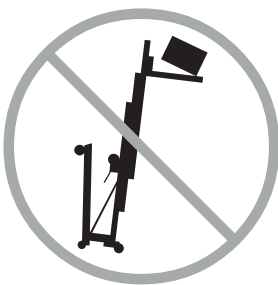

Do not raise the load unless the load handling attachment is properly secured to the machine.

Do not use blocks to level the machine.

Do not move the machine with a raised load, except for minor positioning.

Do not operate the machine in strong or gusty winds. Increasing the load surface area will decrease machine stability in windy conditions.



Do not leave a load raised when windy conditions may occur unless the machine(s) are properly guy-wired.

Do not cause a horizontal force or side load to the machine by raising or lowering a fixed or overhanging load.

Prior to use, check the work area for drop-offs, holes, bumps, debris, unstable or slippery surfaces or other possible hazardous conditions.

Do not place ladders or scaffolding against any part of the machine.

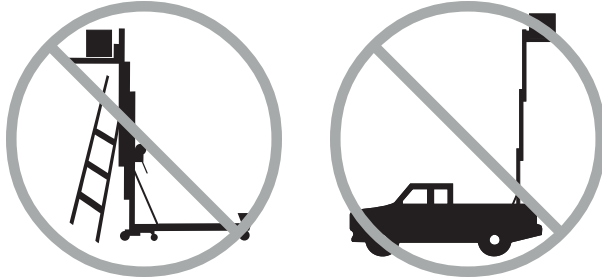

Do not use the machine on a moving or mobile surface or vehicle.

Do not exceed the rated load capacity. See Load Capacity Charts section.

Avoid debris and uneven surfaces while rolling a Genie Superlift with the legs folded up.

Do not replace machine parts critical to stability or structure with items of different weight or specification.

Do not use a straddle base or the flat forks on an SLK-20 or an SLK-25.

Lifting Hazards

Use proper lifting techniques to load or tip the machine.

Use proper lifting techniques when installing or removing the load handling attachments.

Electrocution Hazards

This machine is not electrically insulated and will not provide protection from contact with or proximity to electrical current.



Keep away from the machine if it contacts energized power lines. Personnel must not touch or operate the machine until power lines are shut off.

Maintain safe distances away from electrical power lines and apparatus in accordance with applicable governmental regulations and the following chart.

| Voltage | Minimum Safe Approach Distance | |
|-----------------|--------------------------------|--------|
| | Feet | Meters |
| Phase to Phase | | |
| 0 to 300V | Avoid Contact | |
| 300V to 50KV | 10 | 3.1 |
| 50KV to 200KV | 15 | 4.6 |
| 200KV to 350KV | 20 | 6.1 |
| 350KV to 500KV | 25 | 7.6 |
| 500KV to 750KV | 35 | 10.7 |
| 750KV to 1000KV | 45 | 13.7 |

Allow for mast movement and electrical line sway or sag, and be aware of strong or gusty winds.

Do not use the machine as a ground for welding.

Bodily Injury Hazard

Do not grasp the cable.

SAFETY RULES

Crushing Hazards

Do not raise if the load is not properly centered on the load handling attachment.

Do not raise unless the load is properly secured to the load handling attachment.

Do not stand under or allow personnel under the machine when the load is raised.

Do not stand under the load. The safety brake system (if equipped) will allow the load to drop 1 to 3 feet / 30 to 92 cm before locking the columns.



Do not lower the load unless the area below is clear of personnel and obstructions.

Keep hands and fingers away from folding legs and other potential pinch points.

Maintain a firm grasp on the stabilizer when the lock plates are released. The stabilizer will drop.

Maintain a firm grasp on the leg when the retaining pin is removed. The leg will drop.

Maintain a firm grasp on the winch handles until the brake is locked. The brake is locked when the load will not cause the winch handles to turn.

Adjustable Flat Forks

Do not raise the load unless the snap pins are properly inserted in the forks.



Fork Extensions

Do not raise the load unless the fork extensions are properly secured to the forks.

Collision Hazards

Check the work area for overhead obstructions or other possible hazards.

Do not tilt the machine back unless the area is clear of personnel and obstructions.

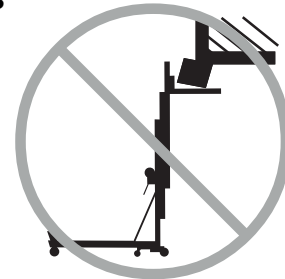

Use common sense and planning when transporting the machine on an incline or slope.

Do not load for transport unless the machine and vehicle are on a level surface. Use proper lifting techniques to load the machine.

Damaged Machine Hazards



Do not use a damaged or malfunctioning machine.

Do not use a machine with a worn, frayed, kinked or damaged cable.

Do not use a machine with less than 4 wraps of cable on the winch drum when the carriage is fully lowered.

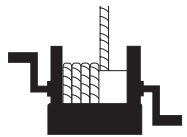

Conduct a thorough pre-operation inspection prior to each use.

Be sure all decals are in place and legible. See Decals section.

Be sure that the operator's manual is complete, legible and in the storage container located on the machine.

Maintain proper lubrication on the winch. See **Genie Superlift Parts and Service Manual** for details. Do not allow oil or grease on braking surfaces.

Do not use any type of lubrication on the column surfaces.

Improper Use Hazard

Never leave a Genie Superlift unattended with a load. Unauthorized personnel may attempt to operate the machine without proper instruction, creating an unsafe condition.

Decal Legend

Genie product decals use symbols, color coding and signal words to identify the following:



Safety alert symbol—used to alert personnel to potential personal injury hazards. Obey all safety messages that follow this symbol to avoid possible injury or death.



Red—used to indicate the presence of an imminently hazardous situation which, if not avoided, will result in death or serious injury.



Orange—used to indicate the presence of a potentially hazardous situation which, if not avoided, could result in death or serious injury.



Yellow with safety alert symbol—used to indicate the presence of a potentially hazardous situation which, if not avoided, may cause minor or moderate injury.



Yellow without safety alert symbol—used to indicate the presence of a potentially hazardous situation which, if not avoided, may result in property damage.



Green—used to indicate operation or maintenance information.

Legend

Standard Forks

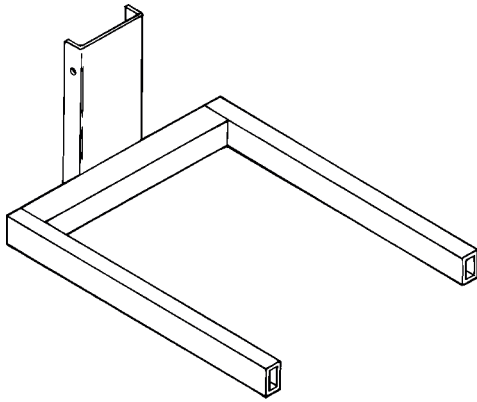

Crane Boom

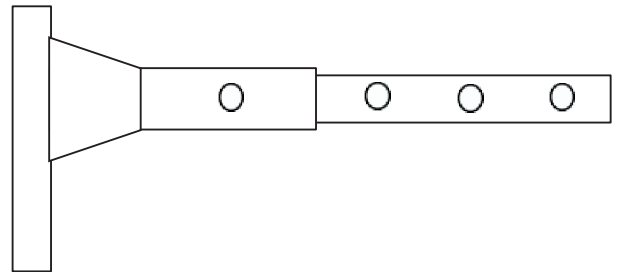

- 01 Mast brace
- 02 Loading wheels/steer handles
- 03 Snap pin
- 04 Lifting shackle
- 05 Fork mounting bracket
- 06 Fork extension
- 07 Fork extension retaining pin

Pre-operation Inspection



Do Not Operate Unless:

- You learn and practice the principles of safe machine operation contained in this operator's manual.

- 1 Avoid hazardous situations.

2 Always perform a pre-operation inspection.

Know and understand the pre-operation inspection before going on to the next section.

- 3 Always perform function tests prior to use.

- 4 Inspect the workplace.

- 5 Only use the machine as it was intended.

Fundamentals

The pre-operation inspection is a visual inspection performed by the operator prior to each work shift. This inspection is designed to discover if anything is apparently wrong with a machine before the operator tests it.

Refer to the list on the next page and check each of the items.

If damage or any unauthorized variation from factory delivered condition is discovered, the machine must be tagged and removed from service.

Repairs to the machine may only be made by a qualified service technician, according to the manufacturer's specifications. After repairs are completed, the operator must perform a pre-operation inspection again before going on to the function tests.

PRE-OPERATION INSPECTION

Pre-operation Inspection

- Be sure that the operator's manual is complete, legible and in the storage container located on the machine.
- Be sure that all decals are legible and in place. See Decals section.

Check the following components or areas for damage, improperly installed or missing parts and unauthorized modifications:

- Winch and related components
- Base components
- Legs
- Stabilizers and latch plates (if equipped)
- Mast columns
- Exterior plastic shim for safety brake (if equipped)
- Carriage hold-down bar
- Cable anchor
- Cable and pulleys
- Wheels and casters
- Load handling attachments
- Nuts, bolts and other fasteners
- Cable (kinks, frays, abrasions)

Check the entire machine for:

- Dents or damage
- Corrosion or oxidation
- Cracks in welds or structural components
- Be sure that all structural and other critical components are present and all associated fasteners and pins are in place and properly tightened.
- Be sure there is a minimum of 4 wraps of cable around the winch drum when the carriage is fully lowered.

Function Tests



Do Not Operate Unless:

- You learn and practice the principles of safe machine operation contained in this operator's manual.

- 1 Avoid hazardous situations.
- 2 Always perform a pre-operation inspection.

3 Always perform function tests prior to use.

Know and understand the function tests before going on to the next section.

- 4 Inspect the workplace.
- 5 Only use the machine as it was intended.

Fundamentals

The function tests are designed to discover any malfunctions before the machine is put into service. The operator must follow the step-by-step instructions to test all machine functions.

A malfunctioning machine must never be used. If malfunctions are discovered, the machine must be tagged and removed from service. Repairs to the machine may only be made by a qualified service technician, according to the manufacturer's specifications.

After repairs are completed, the operator must perform a pre-operation inspection and function tests again before putting the machine into service.

FUNCTIONTESTS

Function Tests

- 1 Select a test area that is firm, level and free of obstructions.

Setup

Machines Without Stabilizers

- 1 Remove the leg retainer pin and lower the leg to the down position. Insert the pin through the leg and base.



Machines With Stabilizers

- 1 Push down to release the stabilizer lock plates and lower the stabilizers until the casters are in full contact with the ground. Be sure the stabilizers are locked in the down position.
- 2 Remove the leg retainer pin and lower the leg to the down position. Insert the pin through the leg and base.

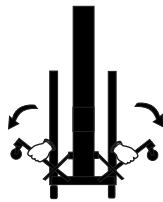

- 3 In working position, the weight box must be placed on the rear locking pins filled with 8 x 16 kg counterweights.

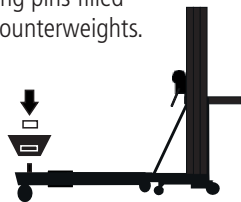

Straddle Base

- 1 Place a 2 inch / 5.1 cm block under one leg swivel caster.
- 2 Loosen the arm lock knob on the opposite adjustable arm. Push down on the lock knob.
- 3 Position the adjustable arm to the desired width.
- 4 Tighten the arm lock knob while supporting the leg assembly.
- 5 Repeat steps 1-4 for the other arm.

Load Handling Attachments

Standard Forks and Standard Fork Options

- 1 Place the forks inside the carriage.
- 2 Insert the retaining pin.

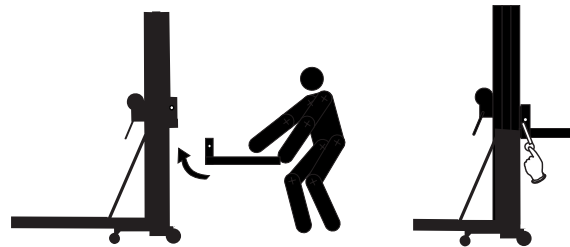

Load Platform with Standard Forks

- 1 Place the load platform on the standard forks.

Pipe Cradle

- 1 Attach the pipe cradles to the forks. Be sure the fasteners are tightened.

Fork Extensions

- 1 Slide each extension tube onto the fork.
- 2 Adjust to the desired position and insert the retaining pins.

Adjustable Forks and Adjustable Fork Options

- 1 Place the forks inside the carriage.
- 2 Insert the retaining pin.

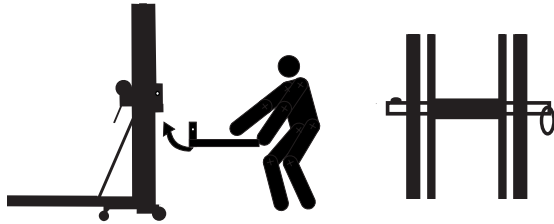

- 3 Adjust the forks to the desired width and be sure the snap pin is properly inserted in each fork.

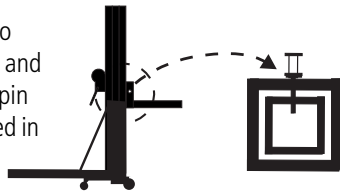

Load Platform with Adjustable Forks

- 1 Adjust the forks to a width of 23 inches / 58.4 cm.
- 2 Place the load platform on the adjustable forks.

Pipe Cradle

- 1 Attach the pipe cradles to the forks. Be sure the fasteners are tightened.

Fork Extensions

- 1 Slide each extension tube onto the forks.
- 2 Adjust to the desired position and insert the retaining pins.

Flat Forks

- 1 Place the fork mounting bracket inside the carriage.
- 2 Insert the retaining pin.



- 3 Adjust the forks to the desired width and be sure the snap pin is properly inserted in each fork.

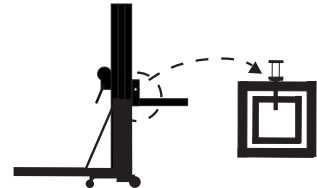

Standard Boom

- 1 Place the boom inside the carriage.
- 2 Insert the retaining pin.

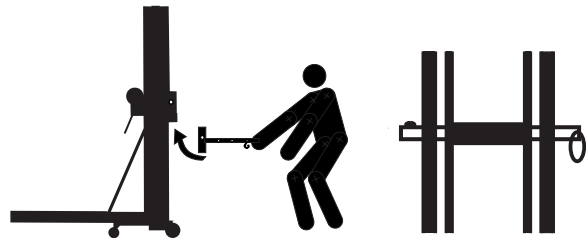

- 3 Attach the lifting shackle to the desired hole on the boom.

FUNCTIONTESTS

Test One-Speed Winch Operation

- 1 Install a load handling attachment.
 - 2 Raise the carriage by firmly grasping the winch handles and rotating them towards the mast.
- ⊙ Result: The winch should operate smoothly, free of hesitation or binding.

- 3 Lower the carriage by firmly grasping the winch handles and rotating them away from the mast. After lowering to the desired position, turn the winch handles toward the mast (raise the load) $\frac{1}{4}$ turn to set the brakes.

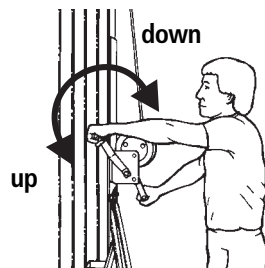

- ⊙ Result: The winch should operate smoothly, free of hesitation or binding.

Test Two-Speed Winch Operation

- 1 Install a load handling attachment.
- 2 Shift the winch to the slow speed.
- 3 Raise the carriage by firmly grasping the winch handles and rotating them towards the mast.

- ⊙ Result: The winch should operate smoothly, free of hesitation or binding.

- 4 Lower the carriage by firmly grasping the winch handles and rotating them away from the mast. After lowering to the desired position, turn the winch handles toward the mast (raise the load) $\frac{1}{4}$ turn to set the brakes.

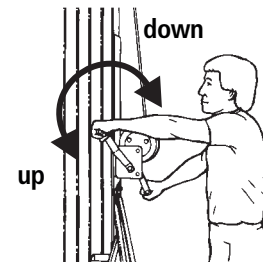

- ⊙ Result: The winch should operate smoothly, free of hesitation or binding.

- 5 Shift the winch to the fast speed and repeat steps 3 and 4.

Test Mast Sequencing

- 1 Install a load handling attachment.
 - 2 Raise the carriage to full height by firmly grasping the winch handles and rotating them towards the mast.
- ⊙ Result: The carriage should raise to the top of the front mast section, followed in consecutive order by each mast section.
- 3 Fully lower the carriage. After lowering to the desired position, turn the winch handles toward the mast (raise the load) $\frac{1}{4}$ turn to set the brakes.

Workplace Inspection



Do Not Operate Unless:

- You learn and practice the principles of safe machine operation contained in this operator's manual.**

1. Avoid hazardous situations.
2. Always perform a pre-operation inspection.
3. Always perform function tests prior to use.

4 Inspect the workplace.

Know and understand the workplace inspection before going on to the next section.

- 5 Only use the machine as it was intended.

Be aware of and avoid the following hazardous situations:

- drop-offs or holes
- bumps and floor obstructions
- debris
- sloped surfaces
- unstable or slippery surfaces
- overhead obstructions and high voltage conductors
- hazardous locations
- inadequate surface support to withstand all load forces imposed by the machine
- wind and weather conditions
- all other possible unsafe conditions

Fundamentals

The workplace inspection helps the operator determine if the workplace is suitable for safe machine operation. It should be performed by the operator prior to moving the machine to the workplace.

It is the operator's responsibility to read and remember the workplace hazards, then watch for and avoid them while moving, setting up and operating the machine.

Operating Instructions



Do Not Operate Unless:

- You learn and practice the principles of safe machine operation contained in this operator's manual.
 - 1 Avoid hazardous situations.
 - 2 Always perform a pre-operation inspection.
 - 3 Always perform function tests prior to use.
 - 4 Inspect the workplace.
 - 5 Only use the machine as it was intended.

Fundamentals

The Operating Instructions section provides instructions for each aspect of machine operation. It is the operator's responsibility to follow all the safety rules and instructions in the operator's manual.

Using the machine for anything other than lifting material is unsafe.

If more than one operator is expected to use a machine at different times in the same work shift, each operator is expected to follow all safety rules and instructions in the operator's manual. That means every new operator should perform a pre-operation inspection, function tests and a workplace inspection before using the machine.

Setup

Select an area that is firm, level and free of obstructions.

Follow the Setup procedures in the Function Tests section.

Raising and Lowering Load

- 1 Center the load on the load handling attachment. See Load Capacity Charts section.
- 2 Secure the load to the load handling attachment.
- 3 Raise the load by firmly grasping the winch handles and rotating them toward the mast. Do not allow the cable to wind unevenly onto the drum.
- 4 Lower the load by firmly grasping the winch handles and rotating them away from the mast. After lowering to the desired position, turn the winch handles toward the mast (raise the load) $\frac{1}{4}$ turn to set the brakes

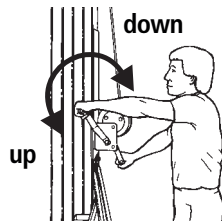

Moving Machine with a Load

It is best to move the machine on the worksite with no load. Moving a raised load should be restricted to positioning for loading and unloading. If it is necessary to move the machine with a raised load, understand and obey the following safety rules:

- Make sure the area is level and clear of obstructions
- Make sure the load is centered on the load handling attachment
- Make sure the load is secured to the load handling attachment
- Avoid sudden starts and stops
- Travel with the load in the lowest possible position
- Keep personnel away from the machine and load

After Each Use

To prepare the Genie Superlift for storage, follow the Setup procedure in reverse order.

Select a safe storage location - firm level surface, weather protected, clear of obstruction and traffic.

Load Capacity Charts



Observe and Obey:

- ☑ Failure to properly position the load may result in death or serious injury.
- ☑ Verify that the load you wish to raise does not exceed the maximum load for your load center. See the Load Capacity Chart on the next page.

⚠WARNING Tip-over hazard. Raising a load that exceeds the machine capacity may result in death or serious injury.

- ☑ A load center is defined as the balancing point (center of gravity) of a load and must be positioned within the load center zone.

⚠WARNING Tip-over hazard. Failure to position the load center within the load center zone may result in death or serious injury.

Forks

Load Positioning Instructions

- 1 Determine the weight of the load and the location of its load center.
- 2 Measure to the load center from the side of the load that will be closest to the carriage.
- 3 Refer to the chart on the next page to determine if the machine is capable of lifting the weight at the location on the forks.
- 4 Place the load so that it rests on the forks, as close to the carriage as possible.
- 5 Position the load so that the load center is within the load center zone.
- 6 Secure the load to the forks.

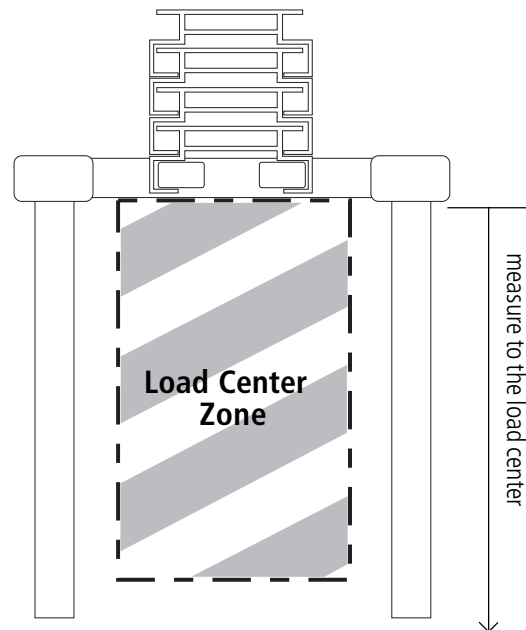

See the chart on the next page for maximum load centers for standard forks, adjustable forks and flat forks.

LOAD CAPACITY CHARTS

Boom

Load Positioning Instructions

- 1 Determine the weight of the load and the location of its load center.
- 2 Refer to the chart below to determine if the machine is capable of lifting the weight at the location on the boom.
- 3 Secure the load to the lifting shackle on the boom.

Maximum Load Centers

(measure from the front of the carriage)

| | Inches | Centimeter |
|-------------------|--------|------------|
| Standard Forks: | 24 in | 61 cm |
| Adjustable Forks: | 24 in | 61 cm |
| Boom: | 42 in | 107 cm |
| Flat Forks: | 28 in | 71 cm |
| Load Platform: | 24 in | 61 cm |
| Pipe Cradle: | 18 in | 46 cm |
| Fork Extensions: | 42 in | 107 cm |

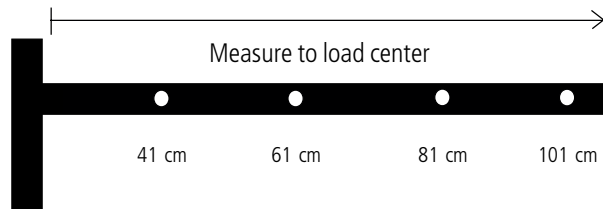

LOAD CAPACITY CHART

| Max. payload in relation to max. loading heights and lift model | | | | | | | | |
|---|--------|--------|--------|--------|--------|--------|--------|--------|
| Lastzentrum: | 36 cm | 41 cm | 51 cm | 61 cm | 71 cm | 81 cm | 91 cm | 101 cm |
| SLK 5 | 450 kg | 450 kg | 369 kg | 303 kg | 248 kg | 203 kg | 167 kg | 137 kg |
| SLK 10 | 450 kg | 450 kg | 369 kg | 303 kg | 248 kg | 203 kg | 167 kg | 137 kg |
| SLK 15 | 360 kg | 360 kg | 295 kg | 242 kg | 198 kg | 163 kg | 133 kg | 109 kg |
| SLK 20 | 360 kg | 360 kg | 295 kg | 242 kg | 198 kg | 163 kg | 133 kg | 109 kg |
| SLK 25 | 300 kg | 300 kg | 246 kg | 202 kg | 165 kg | 136 kg | 111 kg | 91 kg |

Net weight ! All WITHOUT weight of load handling attachments, load, etc.

Transport and Lifting Instructions



Observe and Obey:

- ☑ The transport vehicle must be parked on a level surface.
- ☑ The transport vehicle must be secured to prevent rolling while the machine is being loaded.
- ☑ Be sure the vehicle capacity, loading surfaces and chains or straps are sufficient to withstand the machine weight. See the serial plate for machine weight.
- ☑ The machine must be secured to the transport vehicle with chains or straps of ample load capacity.

Loading the Machine

Be sure to remove the load handling attachment from the machine and place the stabilizers in the stored position.

- 1 Fully lower the carriage, to lock for transport.
- 2 Rotate the carriage hold-down bar over the carriage.
- 3 Raise the carriage until it contacts the carriage hold-down bar.
- 4 Adjust the loading wheels to the desired position. Be sure the pin is properly inserted.

- 5 Lock the rear base casters.



- 6 Place the machine against the vehicle. Use proper lifting techniques to load the machine into the transport vehicle. Be sure to check that the carriage is locked in the lowered position.



- 7 Use a minimum of 1 chain or strap to secure the machine to the truckbed. Place the chain or strap over the mast. Placing the chain or strap over the legs can damage the legs.

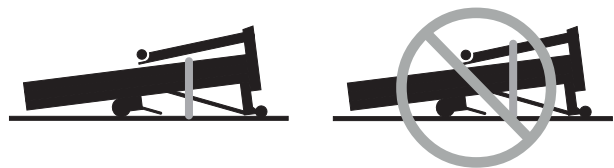

- 8 To unload, follow the loading instructions in reverse order.

Loading Machine with a Crane

Be sure to place the legs and stabilizers in the stored position.

Be sure to inspect the machine and remove any loose or unsecured items.

Use the lifting bracket on the top of the rear mast column.

Always place the lifting hook through the lifting bracket so that it points away from the machine.



Specifications

| Model | SLK-5 | SLK-10 | SLK-15 | SLK-20 | SLK-25 |
|---|-----------------|-----------------|---------|------------|--------|
| Height-Stowed | 2,04 m | 2,04 m | 2,04 m | 2,04 m | 2,04 m |
| Working height | 2,00 m | 3,50 m | 5,00 m | 6,50 m | 7,90 m |
| Length-Stowed | 74 cm | 74 cm | 74 cm | 74 cm | 79 cm |
| Length-Operating | 1,5 m | 1,5 m | 1,8 m | 2,2 m | 2,2 m |
| Load Capacity | 450 kg | 450 kg | 360 kg | 360 kg | 300 kg |
| at 17 inch / 41 cm load center | | | | | |
| Note: see Load Capacity Charts section for load capacities at other load centers. | | | | | |
| Net Weight - Standard Base | 98 kg | 118 kg | 144 kg | 184 kg | 204 kg |
| + 8 Counterweights á 16 kg | 226 kg | 246 kg | 272 kg | 312 kg | 338 kg |
| Incl. 4 steering wheels Ø | 0,20 m | 0,20 m | 0,20 m | 0,20 m | 0,20 m |
| Incl. Standardforks and singlespeed-winch | | | | | |
| Incl. adjustable boomsection | | | | | |
| Load Handling Attachments | Length | Width | Depth | Net Weight | |
| Wienold CCS-450 Crane-System | 96 cm | 42 cm (Höhe) | 25 cm | 16,5 kg | |
| Standardforks | 70 cm | 60 cm | 6,4 cm | 17,2 kg | |
| Adjustable forks | 70 cm | 29 cm bis 76 cm | 6,4 cm | 23,8 kg | |
| Flat forkst | 81 cm | 41 cm bis 79 cm | 3,8 cm | 33,1 kg | |
| Boom | 46 cm bis 1,1 m | 4 cm | 16,5 cm | 15,6 kg | |
| Vertical barrel hook | 53 cm | 74 cm | NA | 22,9 kg | |
| Pivotable barrel hook | 74 cm | 79 cm | NA | 40,8 kg | |
| Pipe Cradle | 70 cm | 63 cm | 15,2 cm | 4,5 kg | |
| Loadplatform | 70 cm | 60 cm | 6,4 cm | 12 kg | |
| Forkextensions (each) | 76 cm | 5 cm | 7,6 cm | 2 kg | |

Product specifications are subject to change without notice or obligation.

| SLK 25 | | <i>Wheel load table</i> | | | | |
|---------------------|----------------------|-------------------------|---------------|---------------|---------------|---------------|
| Load center: | (Basis) | 42 cm | 51 cm | 59 cm | 81 cm | 107 cm |
| Pay Load (max.): | only crane outrigger | 300 kg | 246 kg | 202 kg | 165 kg | 91 kg |
| Wheel load (front): | 113 kg | > 300 kg | 277 kg | 246 kg | 245 kg | 181 kg |

SPECIFICATIONS

| Dimensions | | SLK-5 | SLK-10 | SLK-15 | SLK-20 | SLK-25 |
|---|--|---|---|---|---|---|
| Standard Forks | forks down | 4 ft 10 ¹ / ₂ in 1.5 m | 9 ft 9 in 3 m | 14 ft 7 ¹ / ₂ in 4.5 m | 19 ft 6 in 5.9 m | 24 ft 4 in 7.4 m |
| | forks up | 6 ft 7 in 2 m | 11 ft 5 ¹ / ₂ in 3.5 m | 16 ft 4 in 5 m | 21 ft 2 ¹ / ₂ in 6.5 m | 26 ft ¹ / ₂ in 7.9 m |
| Adjustable Forks | rks down | 4 ft 10 ¹ / ₂ in 1.5 m | 9 ft 9 in 3 m | 14 ft 7 ¹ / ₂ in 4.5 m | 19 ft 6 in 6 m | 24 ft 4 in 7.4 m |
| | forks up | 6 ft 7 in 2 m | 11 ft 5 ¹ / ₂ in 3.5 m | 16 ft 4 in 5 m | 21 ft 2 ¹ / ₂ in 6.5 m | 26 ft ¹ / ₂ in 7.9 m |
| Flat Forks | | 4 ft 10 ¹ / ₂ in 1.5 m | 9 ft 9 in 3 m | 14 ft 7 ¹ / ₂ in 4.5 m | NA | NA |
| Boom | | 5 ft 10 ¹ / ₂ in 1.8 m | 10 ft 9 in 3.3 m | 15 ft 7 ¹ / ₂ in 4.8 m | 20 ft 6 in 6.2 m | 24 ft 4 in 7.4 m |
| Note: measured from ground to bottom of shackle | | | | | | |
| Load Platform | forks down | 4 ft 10 ¹ / ₂ in 1.5 m | 9 ft 9 in 3 m | 14 ft 7 ¹ / ₂ in 4.5 m | 19 ft 6 in 6 m | 24 ft 4 in 7.4 m |
| | forks up | 6 ft 7 in 2 m | 11 ft 5 ¹ / ₂ in 3.5 m | 16 ft 4 in 5 m | 21 ft 2 ¹ / ₂ in 6.5 m | 26 ft ¹ / ₂ in 7.9 m |
| Note: can be used with standard forks and adjustable forks only | | | | | | |
| Pipe Cradle Option | handles round objects up to 30 in / 76 cm in diameter | | | | | |
| Note: can be used with standard forks and adjustable forks only (see above for working heights) | | | | | | |
| Non-marking Fork Option | | | | | | |
| Note: can be used with standard forks and adjustable forks only (see above for working heights) | | | | | | |
| Fork Extension Option | adds 6 ¹ / ₄ to 25 inches / 15 to 64 cm of length to forks | | | | | |
| Note: can be used with standard forks and adjustable forks only (see above for working heights) | | | | | | |
| Airborne Noise Emissions by Machinery | | 85 dB | 85 dB | 85 dB | 85 dB | 85 dB |
| Maximum sound level at normal operating workstations (A-weighted) | | | | | | |



A series of horizontal lines for writing, consisting of 25 evenly spaced lines that fill the majority of the page below the thick header line.

Norbert Wienold GmbH
Industriegebiet Waldstr. 35a
D-48488 Emsbüren | Germany

Tel. +49 (0) 59 03 - 93 94 0
Fax +49 (0) 59 03 - 93 94 50

www.wienold-lifte.de
e-mail: info@wienold-lifte.de

München - Frankfurt
Leverkusen - Walsrode
Brandenburg - Emsbüren